



Super Bike Speedway

BEFORE YOU BEGIN ...

1. Unpack the parts. Save the packing materials.
2. Match the parts to the drawings below.
3. If you have each part, put a check in the box next to the picture of the part. Look in the carton again and check all of the packing materials to make sure you haven't missed anything.



WARNING

CHOKING HAZARD-Small parts.

Not for Children Under 3 Years

CHECK LIST

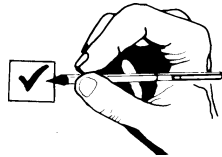

DARDA MOTORCYCLE (1)



SMALL JOINER (2)



LOOP HALVES (4)

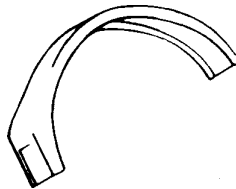

14" STRAIGHT TRACK (4)

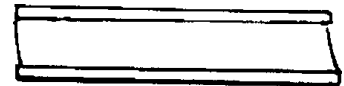

CURVED SUPPORT TRACK (4)



BASEPLATE (3)

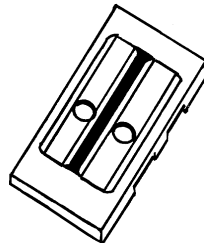

LOOP JOINERS (4)

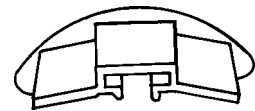

TRACK JOINERS (8)

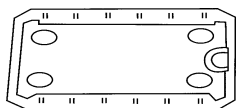

FLEXI-CURVE (4)

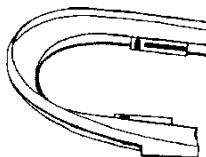

BARS (4)

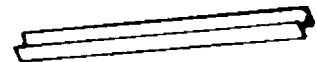

IF A PART IS MISSING OR DAMAGED ...

The store where you purchased this item does not have parts. You will get the easiest service from **Darda, A Division of Life-Like Products, LLC**. Tell us the part(s) needed and be sure to include your name and address printed clearly. Mail to **DARDA** / 1600 Union Avenue / Baltimore, MD 21211 / ATTN: Dock 2

Using Track Joiners

Slide the Track Joiner - with the raised edges facing down - half way into the channel on the underside of the track piece. Now slide the adjoining track piece over the open half of the joiner, so that it meets the first piece. Be sure the tracks meet with no gaps.

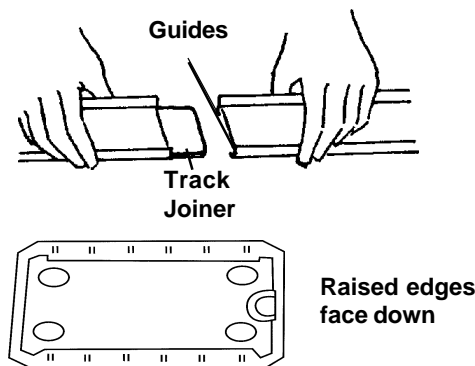

Making Loops

Put two loop halves together so that the pins at the top of each loop half go into the proper holes, creating a tight fitting seam between the two loop halves.

Holding the loop halves together, slide one loop joiner over one end of the seam and the other loop joiner over the other end of the seam.

***IMPORTANT: Make the 2 Loops in this set before building the track.**

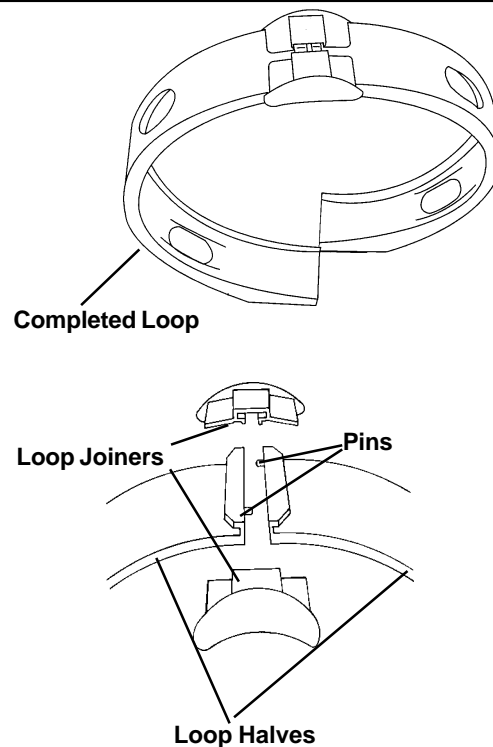

Small Baseplates

ATTACHING LOOPS & TRACKS TO SMALL BASEPLATES:

Each small baseplate has 2 built-in track joiners for joining loops and track pieces together. Slide the end of the loop onto the built-in track joiner on the small baseplate. Then slide the other end of the loop onto the adjacent track joiner on the small baseplate, facing the opposite way. The loop should now be attached to the baseplate. Later, you will attach other track pieces to the loop, using the empty spaces in built-in track joiners.

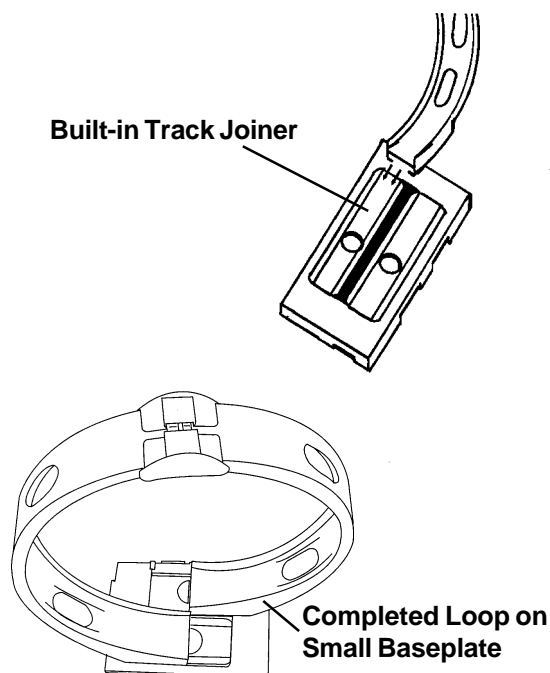

STEP 1

- Using (2) **Baseplates**, (1) **Loop**, (2) **14" Straight Tracks**, (2) **Track Joiners** and (1) **Flexi-Curve**, create the track shown to the right.

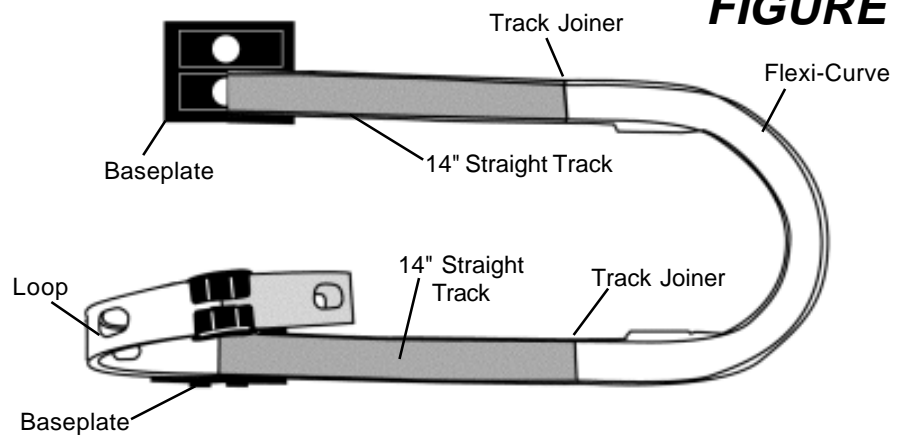

FIGURE 1

STEP 2

- Connect (2) **14" Straight Tracks**, (1) **Flexi-Curve**, (1) **Baseplate** and (1) **Loop** to the pieces you have just assembled. Begin adding the pieces where indicated in **FIGURE 2** and work your way around.

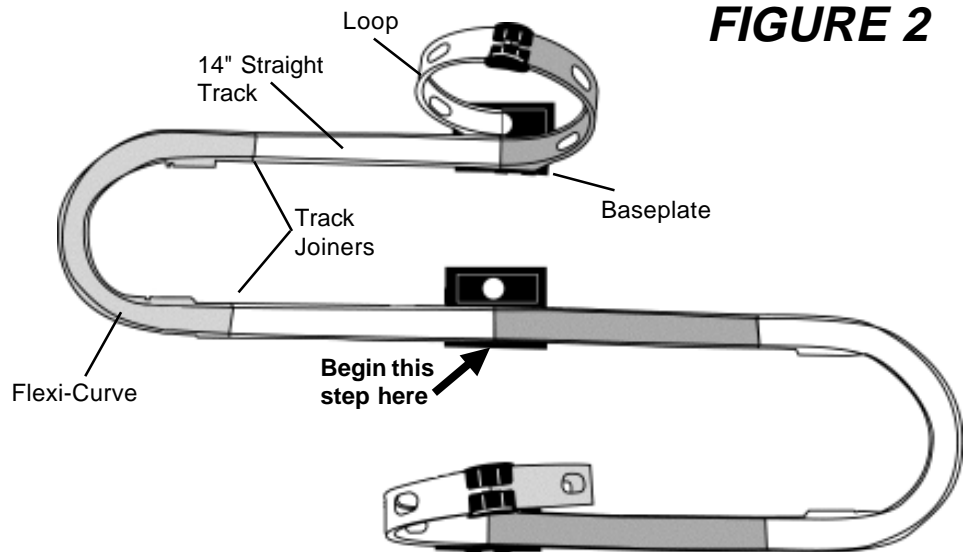

FIGURE 2

STEP 3

- Using the empty built-in track joiners on the baseplates, connect 4 curved support tracks where indicated in **FIGURE 3**.

- Using track joiners, attach (2) **Flexi-Curves** to the curved support tracks. The flexi-curves will be lifted off the ground. See **FIGURE 3**.

- Once you have completed your set, attach 2 bars together using a small joiner as shown in **Figure 3**. Attach the joined bars to the Flexi-Curve through the notches on the interior of the curves. These will help stabilize the layout. Repeat on the other raised Flexi-Curve.

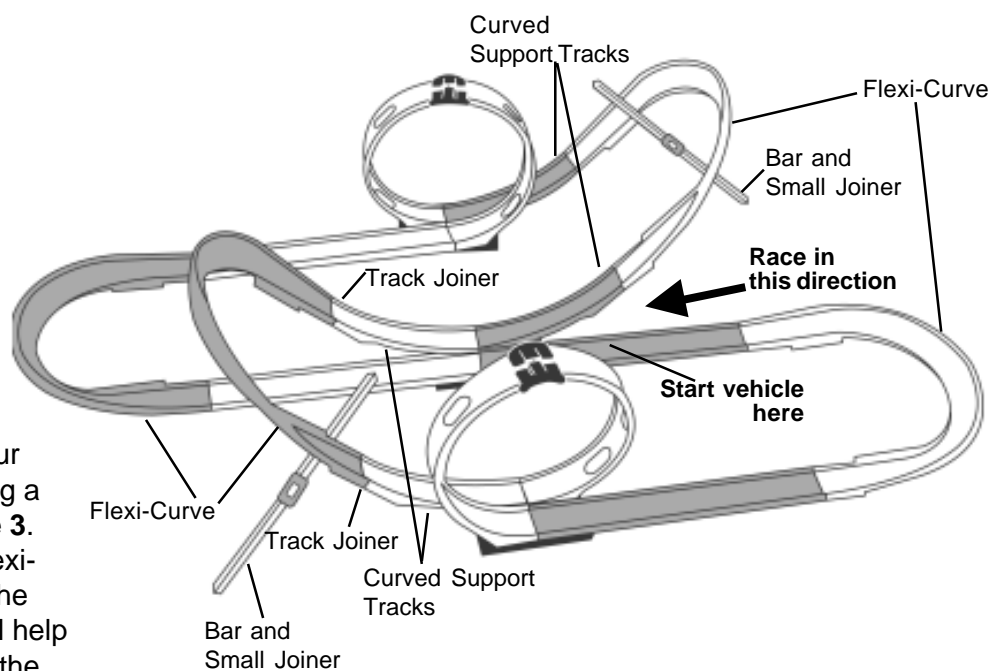
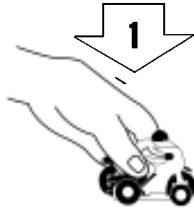

FIGURE 3

STEP 4 - Get set, go!

Place your vehicle on the track where indicated in **FIGURE 3**

1. Press down on vehicle body until you hear a click.



2. While still pressing down, roll vehicle back & forth until the clicking sound gets louder.

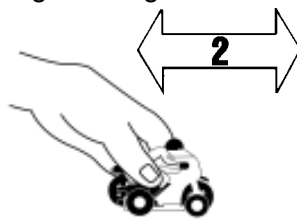

3. Lift your hand up off the vehicle while rolling forward. Watch it go!

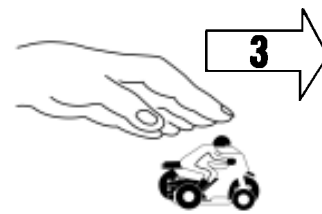

Tips

- Be sure that the vehicle is fully wound by listening for the click to get louder before releasing it.
- Have fun with your Darda vehicles on or off the Darda track. For longer life **do not** run on carpet.
- Replacement motors are available at your local specialty toy store; or contact Darda at the address on page 1 of these instructions.

ALTERNATE TRACK LAYOUTS

Create these exciting track layouts with the pieces in this set.

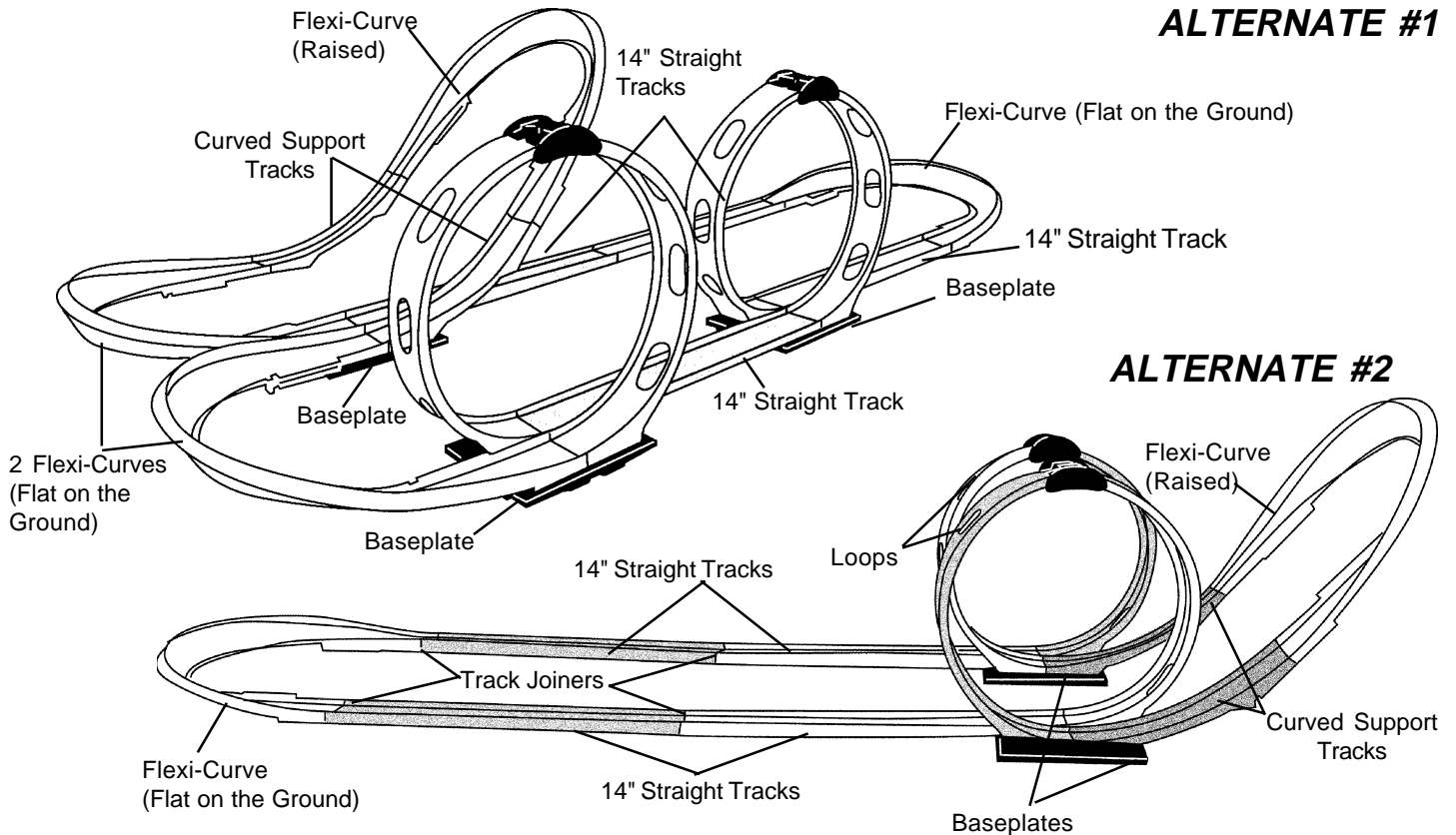

TRACK TIPS

- Read all assembly instructions carefully.
 - If your vehicle has trouble making it around the track, try the following: 1) Be sure that all track seams meet and connections are secure. Track pieces must meet flush against each other where they are connected with track and loop joiners, without gaps or bumps at the joint. 2) It may be necessary to play with, adjust, or slightly bend loops in track layouts to maximize performance. Remember Darda track is flexible.
 - Darda track layouts can be set up on any flat surface. While it is not ideal, your track can be set up on carpet. We do recommend dusting off the track before use so that the dust particles from the carpet do not jam the motor. We do not recommend running the vehicle itself on carpet.
- Double check your assembly instructions, if you still have difficulty we want to help! Call our toll free consumer hotline... 1-800-638-1470. (Mon.-Fri., 9:00A.M.-3:30P.M. (Eastern Standard Time))